



OVENTION[®]

A HATCO[®] CORPORATION COMPANY



Ovention Plant
STURGEON BAY, WI

Ovention Customer Service
MILWAUKEE, WI

Employee owned

Ovention ovens are designed and manufactured in the heartland of the USA. Between our manufacturing facility in Sturgeon Bay, WI and our first-class customer service based in Milwaukee, WI, Ovention is committed to serving you and making ourselves accessible to you.

We take pride in providing you with a premium-quality design worthy of your business.

The Ovention® advantage

LABOR SAVINGS

Patented technologies like auto-loading and unloading save valuable time.

ENERGY EFFICIENCY*

Energy savings and ease of use help you serve food faster and easier with a reduced carbon footprint.

VENTLESS TECHNOLOGY

UL®-KNLZ certified ventless ovens give you more installation flexibility, which saves you money.

FAST DELIVERY

With one of the industry's shortest lead times, we ensure you get what you ordered, when you need it.

CULINARY SUPPORT

Our culinary team, convenient online Menu Builder, and other resources and tools are here to support you and your menu creation.

SOUS VIDE ADVANTAGE

All Ovention ovens can do both finishing and retherming of sous vide-cooked food perfectly.

*See energy efficiency section on oven pages for more details.

UL® is a trademark of Underwriters Laboratories, Inc.



Cook with complete versatility

At Ovention, we think ovens should be smart enough to cook your entire menu perfectly, every time.



Ovention® Technologies

Precision Impingement® Technology

Precision Impingement utilizes hot air for a fast, high-quality cook without microwaves. With three times the airflow velocity, speed and quality increases – giving you delicious food every time.

Precision Impingement Technology:
Matchbox® M360-12 and -14,
Matchbox® M1718/1313,
Shuttle® S1200/1600/2000/2600,
Conveyor C1400/2000/2600

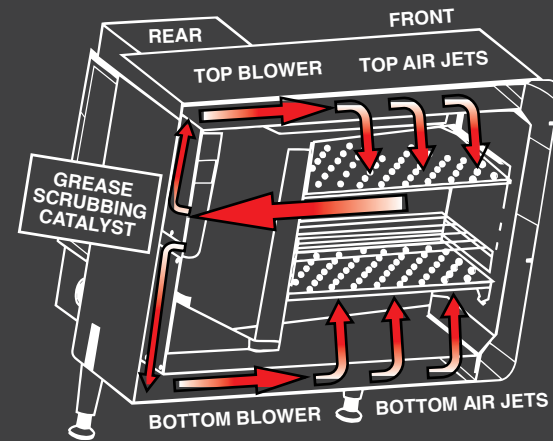

Microwave Speed Assist

MiSA® brings microwave technology to the Ovention® line. That's right - microwave. MiSA brings efficiency, performance, and quality to rapid cooking. Consistent browning with our patent-pending artisanal plate, low energy consumption, and easy cleanup are just a few of the reasons you will be glad to have MiSA at your disposal for all of your rapid cooking needs.

Microwave Speed Assist: MiSA®-a12

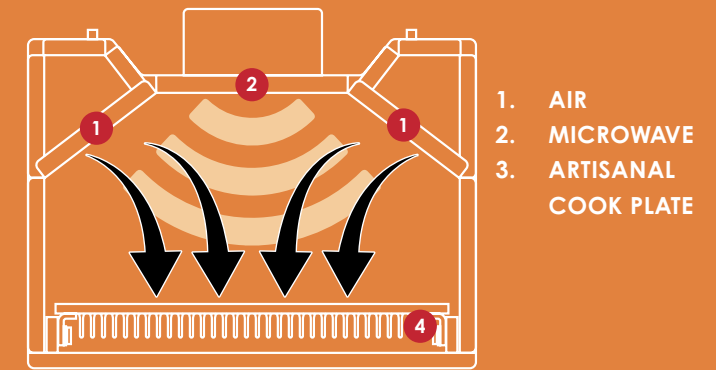

Linear Impingement and Infrared

MiLO® uses a first-of-its-kind, patented technology called Linear Impingement and Infrared (IR), the first successful integration of hot air and IR in an oven that applies the strength of each technology. The hot air in the enclosed cavity allows for even, consistent cooking and a higher yield. The IR elements on both top and bottom of each cavity provide more efficient caramelization without over-drying.

**Linear Impingement and Infrared: Single MiLO® 14,
Single MiLO® 16, Double MiLO2® 16**

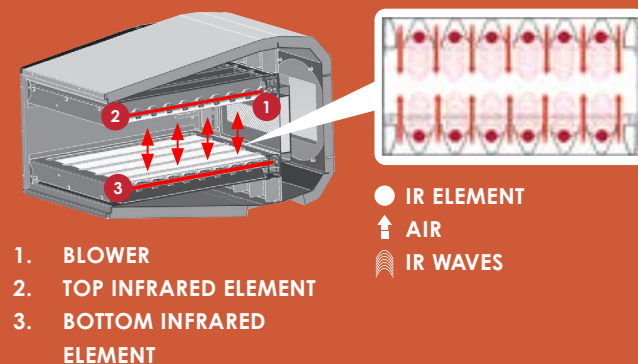

Infrared Only Finishing

The F1400 is a robust infrared (IR) conveyor oven. This operator-friendly conveyor will sear, melt, toast, and finish your food products to perfection.

Infrared Only Finishing: F1400

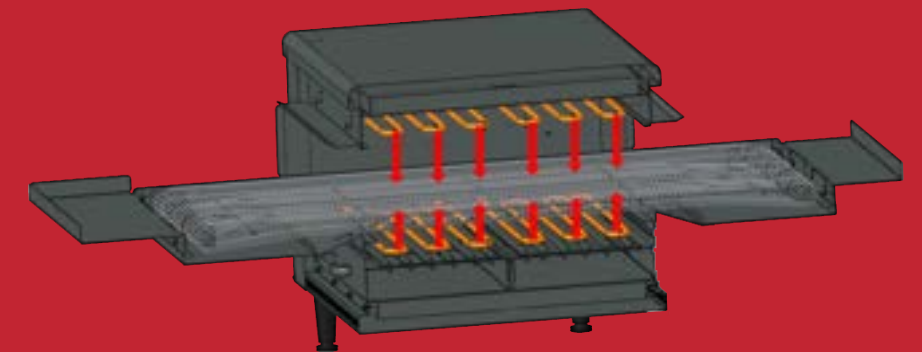

Ventless certified

- UL®-KNLZ certified for operation *without* a Type 1 hood in accordance with EPA 202 test.
- UL listed for multiple stacking configurations.
- Performs up to 10x better than the required UL grease emissions standard.



Ovention® emissions test results

Limit = 5.0mg/m³

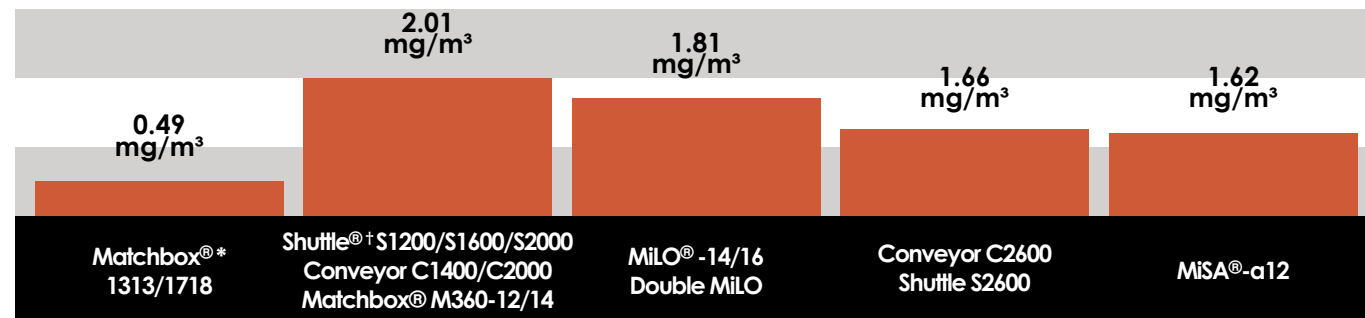

* The value shown reflects the largest unit tested for this model. The smaller units did not require EPA 202 testing by UL since the larger units were all below the 5.0 mg/m³ limit.

† The S2000 Shuttle® was tested in conveyor mode because it was determined to be the most demanding condition.

‡ Shuttle testing was done in conveyor mode. "Shuttle Only Mode" approved at 0.75 mg/m³.

† The F1400 is UL®-KNLZ listed with ventless operation for re-thermalization of pre-cooked product

UL® is a registered trademark of Underwriters Laboratories, Inc.

How quiet is an Ovention® oven?

OVEN	dB
Finishing Oven F1400	54
MiLO® 2-16	68
Matchbox® 1718	66
Conveyor 2000	66
MiSA®-a12	64
Shuttle® 2000	62
TurboChef® 2020	79
TurboChef® Double Batch	81
TurboChef® Bullet	76
Ambient	44
Normal Conversation	60
Lawn Mower	85

Measurement was taken 2 feet in front of the oven. Ambient was measured before each oven. **A 10 dB increase is equal to a doubling in volume.**

TurboChef® is a trademark of TurboChef Technologies, Inc.

There's an
Ovention® oven
right for you!



Matchbox® 1313/1718



Matchbox® M360-12/14



Shuttle® 1200/1600/2000/2600



Conveyor 1400/2000/2600



MiLO® Single 14/Single 16/Double 16



Finishing Oven F1400



MiSA®-a12

Matchbox® | Sizes 1313/1718

Matchbox utilizes our patented Precision Impingement® and labor-saving dual auto loading and unloading technologies. Customize cook time, independent blower speeds and temperature for each item, so you get maximum cooking control and incredible quality.





Available with remote control box for additional installation options

STANDARD FEATURES

- Patented sealed cooking chamber with 2 to 8 times the airflow rate reduces cook times and lowers energy consumption lessening operating costs by 40-50%, compared to a traditional conveyor oven
- Independently controlled top and bottom Precision Impingement air with variable-speed
- Labor saving patented dual auto-load and unload technology
- FlexTemp™ dynamic temperature management allows ±50° F between cook cycles
- Quiet; maximum decibel (dB) level of 66
- Certified UL®-KNLZ ventless; stackable
- 1 year parts and labor warranty

OPERATION AND PERFORMANCE

- Intuitive front-facing touchscreen controls can store 1000+ multistage recipes
- Industry-leading online Menu Builder and recipe software allows for easy menu creation and management via USB
- Self-diagnostics for monitoring oven components and performance
- High visibility countdown timers
- Grill, roast, bake, steam, broil, and air fry
- Easy-to-clean design
- Use any oven-safe pans

	 Matchbox® 1313	 Matchbox® 1718
Heating Technology	Precision Impingement®	Precision Impingement®
Capacity		
Maximum Pan Size	Quarter Sheet Pan 12"	Half Sheet Pan 16"
Maximum Pie Size		
Exterior Dimensions		
Height without Legs (legs approx. 4")	16.24" (413mm)	16.24" (413mm)
Width	50.08" (1272mm)	61.89" (1572mm)
Depth	29.02" (737mm)	34.60" (879mm)
Cook Cavity		
Height x Width x Depth	3.5"x13"x13" (89x330x330mm)	3.5"x17"x18" (89x432x458mm)
Cook Surface/Belt Width x Depth	N/A	N/A
Belt Options	N/A	N/A
Features		
Stackable	Double/Triple	Double/Triple
Recipe Stages	Multi-stage Recipe	Multi-stage Recipe
USB Compatible	USB Compatible	USB Compatible
UL® Ventless	Ventless	Ventless
Power		
Plug	NEMA 6-30 NEMA 6-30	NEMA 6-50
Energy Efficiency**		
Total Energy Cost/Day	\$2.81	\$4.52
Total Energy Cost/Month	\$84.00	\$136.00
Total Energy Cost/Year	\$1,010.00	\$1,627.00
Average Load		
Watts	2,814 W	3,425 W
kBTU/hour	7.3 kBTU/hour	11.7 kBTU/hour
Ton of AC	0.61 Tons of AC	0.97 Tons of AC
Operating Assumption		
Cooking Mode	25% of day 3 hrs/day	25% of day 3 hrs/day
Idle Mode	75% of day 9 hrs/day	75% of day 9 hrs/day
Energy Save Mode	N/A	N/A
Idle-Open Oven	N/A	N/A
Cooking Shuttle	N/A	N/A
Cooking Conv.	N/A	N/A

This product is covered by patents in the US and other countries. UL® is a trademark of Underwriters Laboratories, Inc.

** Assuming \$0.11 energy cost and 12 hours of operation/day.

SCAN HERE TO
VIEW SPEC SHEET



Matchbox® M360 | Size 12/14*

Matchbox M360 has all of the benefits of the Matchbox in a smaller footprint with a unique carousel loading platform. It utilizes our labor-saving patented dual auto-load and unload technology. Customize cook time, independent blower speeds and temperature for each item, so you get maximum cooking control and incredible quality.





STANDARD FEATURES

- Patented sealed cooking chamber with 2 to 8 times the airflow rate reduces cook times and lowers energy consumption lessening operating costs by 40-50%, compared to a traditional conveyor oven
- Independently controlled top and bottom Precision Impingement air with variable-speed
- Patented dual auto-load and unload capability with 360° rotating deck
- FlexTemp dynamic temperature management allows $\pm 25^{\circ}$ F between cook cycles
- Certified UL®-KNLZ ventless; stackable
- 1 year parts and labor warranty

OPERATION AND PERFORMANCE

- Intuitive, front-facing touchscreen controls can store 1000+ multistage recipes
- Industry-leading online Menu Builder and recipe software allows for easy menu creation and management via USB
- Self-diagnostics for monitoring oven components and performance
- High visibility countdown timers
- Grill, roast, bake, steam, broil, and air fry
- Easy-to-clean design
- Use any oven-safe pans

*New Generation Coming Soon

	 Matchbox® M360-12	 Matchbox® M360-14
Heating Technology	Precision Impingement®	Precision Impingement®
Capacity		
Maximum Pan Size	Quarter Sheet Pan	Quarter Sheet Pan
Maximum Pie Size	12"	14"
Exterior Dimensions		
Height without Legs (legs approx. 4")	15.9" (405mm)	15.9" (405mm)
Width	29.4" (747mm)	33.69" (856mm)
Depth	37.3" (947mm)	42.1" (1069mm)
Cook Cavity		
Height x Width x Depth	3.5"x23.9"x12.3" (89x607x311mm)	3.75"x28.25"x14.2" (96x718x361mm)
Cook Surface/Belt Width x Depth	23.88"x12.15" (606x309mm)	27.9"x14.15" (709x359mm)
Belt Options	N/A	N/A
Features		
Stackable	No	No
Recipe Stages	Multi-stage Recipe	Multi-stage Recipe
USB Compatible	USB Compatible	USB Compatible
UL® Ventless	Ventless	Ventless
Power		
Plug	NEMA 6-30	NEMA 6-50
Energy Efficiency**		
Total Energy Cost/Day	\$2.73	\$3.75
Total Energy Cost/Month	\$81.78	\$112.62
Total Energy Cost/Year	\$981.34	\$1351.43
Average Load		
Watts	2,065 W	2,844 W
kBTU/hour	7.1 kBTU/hour	9.71 kBTU/hour
Ton of AC	0.59 Tons of AC	0.81 Tons of AC
Operating Assumption		
Cooking Mode	25% of day 3 hrs/day	25% of day 3 hrs/day
Idle Mode	75% of day 9 hrs/day	75% of day 9 hrs/day
Energy Save Mode	N/A	N/A
Idle-Open Oven	N/A	N/A
Cooking Shuttle	N/A	N/A
Cooking Conv.	N/A	N/A

This product is covered by patents in the US and other countries. UL® is a trademark of Underwriters Laboratories, Inc.

** Assuming \$0.11 energy cost and 12 hours of operation/day.

SCAN HERE TO
VIEW SPEC SHEET



Shuttle® | Sizes 1200/1600/2000/2600^{NEW!}

The Shuttle sets the new standard for conveyor ovens everywhere. It combines the throughput benefits of an impingement conveyor as well as a closed cavity oven, all using our advanced Precision Impingement® technology. No other oven can operate as both a conveyor and a closed-cavity oven.

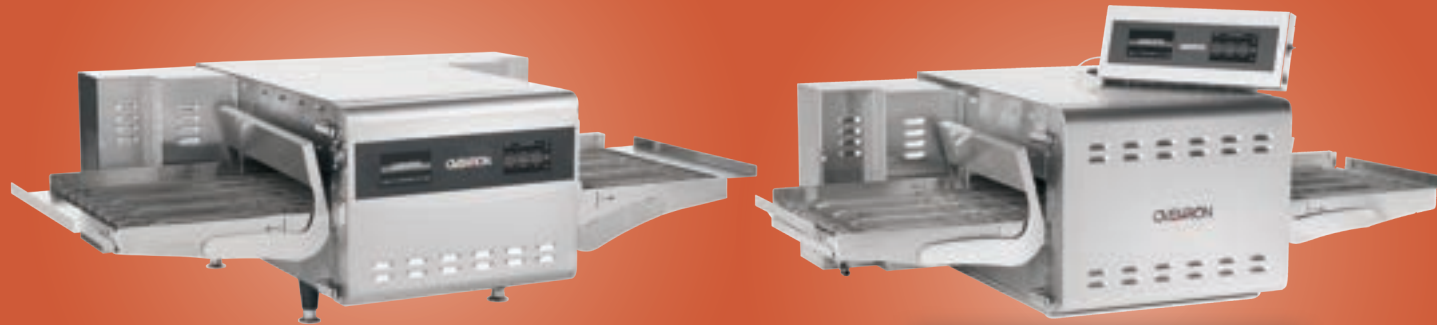



Available with remote control box for additional installation options

STANDARD FEATURES

- Operate in either high-performance Conveyor or patented Shuttle mode with sealed baking chamber for menu flexibility and energy efficiency
- Independently controlled top and bottom Precision Impingement air
- Left or right feed conveyor belt direction changeable with control settings for linear flow
- Patented dual auto-load and unload capability
- FlexTemp dynamic temperature management allows $\pm 25^\circ$ F between cook cycles
- Factory programmed Power Save setting for maximum energy conservation
- Quiet; maximum decibel (dB) level of 62
- Certified UL®-KNLZ ventless; stackable
- 1 year parts and labor warranty

OPERATION AND PERFORMANCE

- Store 1000+ multistage recipes
- Industry-leading online Menu Builder and recipe software allows for easy menu creation and management via USB
- Self-diagnostics for monitoring oven components and performance
- High visibility countdown timers
- Grill, roast, bake, steam, broil, and air fry
- Easy-to-clean design
- Use any oven-safe pans

	 Shuttle® 1200	 Shuttle® 1600	 Shuttle® 2000	 Shuttle® 2600
Heating Technology	Precision Impingement®	Precision Impingement®	Precision Impingement®	Precision Impingement®
Capacity				
Maximum Pan Size	Half Sheet Pan (horizontally)	Half Sheet Pan	Full Sheet Pan or Full Hotel Pan	Full Sheet Pan or Full Hotel Pan
Maximum Pie Size	14" (Conveyor mode) 12" (Shuttle mode)	16"	20" (Conveyor mode) 16" (Shuttle mode)	26" (Conveyor mode) 16" (Shuttle mode)
Exterior Dimensions*				
Height without Legs (legs approx. 4")	16.24" (413mm)	16.62" (422mm)	16.24" (413mm)	16.24" (413mm)
Width	44.22" (1123mm)	56.84" (1494mm)	48.25" (1225mm)	63.35" (1610mm)
Depth	31.05 (789mm)	32.91" (836mm)	37.01" (940mm)	43.01" (1092mm)
Cook Cavity				
Height x Width x Depth	3.5"x17"x14.6" (89x434x371mm)	3.5"x21"x16.54" (89x533x420mm)	3.5"x21"x20.54" (89x533x522mm)	3.5"x21"x26.54" (89x533x674mm)
Cook Surface/Belt Width x Depth	44.10"x14" (1120x356mm)	56.75"x16" (1441x660mm)	56.75"x20" (1441x508mm)	56.75"x26" (1441x660mm)
Belt Options	N/A	N/A	N/A	N/A
Features				
Stackable	Double/Triple	Double/Triple	Double/Triple	Double
Recipe Stages (Shuttle mode only)	Multi-stage Recipe	Multi-stage Recipe	Multi-stage Recipe	Multi-stage Recipe
USB Compatible	USB Compatible	USB Compatible	USB Compatible	USB Compatible
UL® Ventless	Ventless	Ventless	Ventless	Ventless
Power				
Plug	NEMA 6-30 NEMA 6-50	NEMA L15-30	NEMA 6-50 NEMA 15-50	NEMA 15-50
Energy Efficiency**				
Total Energy Cost/Day	\$2.97	\$3.71	\$3.99	\$4.19
Total Energy Cost/Month	\$89.03	\$111.00	\$120.00	\$125.67
Total Energy Cost/Year	\$1,068.37	\$1,335.00	\$1,436.00	\$1,508.07
Average Load***				
Watts	2,248 W	2,810 W	3,022 W	3,174 W
kBTU/hour	7.7 kBTU/hour	9.6 kBTU/hour	10.3 kBTU/hour	10.84 kBTU/hour
Ton of AC	0.64 Tons of AC	0.80 Tons of AC	0.86 Tons of AC	0.9 Tons of AC
Operating Assumption				
Cooking Mode	N/A	N/A	N/A	N/A
Idle Mode	N/A	N/A	N/A	N/A
Energy Save Mode	75% of day 9 hrs/day	75% of day 9 hrs/day	75% of day 9 hrs/day	75% of day 9 hrs/day
Idle-Open Oven	0% of day 0 hrs/day	0% of day 0 hrs/day	0% of day 0 hrs/day	0% of day 0 hrs/day
Cooking Shuttle	25% of day 3 hrs/day	25% of day 3 hrs/day	25% of day 3 hrs/day	25% of day 3 hrs/day
Cooking Conv.	0% of day 0 hrs/day	0% of day 0 hrs/day	0% of day 0 hrs/day	0% of day 0 hrs/day

* Different sized endstops available for Shuttles and Conveyors. Cook cavity dimensions are listed without endstops. Ovention is constantly improving and expanding our portfolio of cooking solutions. Visit oventionovens.com for more details.

This product is covered by patents in the US and other countries. UL® is a trademark of Underwriters Laboratories, Inc.

** Assuming \$0.11 energy cost and 12 hours of operation/day.

*** Additional and export plug configurations available upon request.

SCAN HERE TO VIEW SPEC SHEET



Conveyor | Sizes 1400/2000/2600

Simple, smart and the right fit for operators seeking a high-throughput conveyor oven. The most technologically elegant and operator-friendly conveyor on the market today.





Available with remote control box for additional installation options

STANDARD FEATURES

- Independently controlled top and bottom Precision Impingement® air with variable-speed recirculation
- Direction of the left or right feed conveyor belt is changeable with control settings
- Power Save setting available from the factory or programmable on-site for maximum energy conservation
- Quiet; maximum decibel (dB) level of 66
- Certified UL®-KNLZ ventless; stackable
- 1 year parts and labor warranty

OPERATION AND PERFORMANCE

- Intuitive front-facing touchscreen controls can store 36+ recipes
- Industry-leading online Menu Builder and recipe software allows for easy menu creation and management via USB
- Self-diagnostics for monitoring oven components and performance
- High visibility countdown timers
- Grill, roast, bake, steam, broil, and air fry
- Easy-to-clean design
- Use any oven-safe pans

	 Conveyor 1400	 Conveyor 2000	 Conveyor 2600
Heating Technology	Precision Impingement®	Precision Impingement®	Precision Impingement®
Capacity			
Maximum Pan Size Maximum Pie Size	Half Sheet Pan 14"	Full Hotel Pan 18" or full sheet pan for pan size 20" for pie size	Full Sheet Pan or Full Hotel Pan 26"
Exterior Dimensions*			
Height without Legs (legs approx. 4") Width Depth	16.24" (413mm) 40.21" (1021mm) 31.11" (790mm)	16.24" (413mm) 48.00" (1219mm) 37.01" (940mm)	16.24" (413mm) 48.00" (1219mm) 43.01" (1092mm)
Cook Cavity			
Height x Width x Depth Cook Surface/Belt Width x Depth Belt Options	3.5"x17"x14.6" (89x434x371mm) 38.5"x14" (978x356mm) Single Belt	3.5"x21"x20.54" (89x533x522mm) 20"x48" (508x1219mm) Single Belt: 48x20" (1219x508mm) 50/50 Belt: 9.5"x9.5" (241x241mm)	3.5"x21"x26.54" (88.9x533x674mm) 48"x26" (1219x660mm) Single Belt: 26" (660mm) 50/50 Belt: 12.5"x12.5" (318x318mm) 70/30 Belt: 17"x8" (432x203mm)
Features			
Stackable Recipe Stages USB Compatible UL® Ventless	Double/Triple Single Stage Recipe USB Compatible Ventless	Double/Triple Multi-stage Recipe USB Compatible Ventless	Double Multi-stage Recipe USB Compatible Ventless
Power			
Plug	NEMA 6-50 NEMA L15-30 NEMA 15-50	NEMA 15-50 NEMA 6-50	NEMA 15-50
Energy Efficiency**			
Total Energy Cost/Day Total Energy Cost/Month Total Energy Cost/Year	\$5.60 \$168.00 \$2,016.00	\$6.77 \$203.00 \$2,439.00	\$8.69 \$260.79 \$3,129.45
Average Load***			
Watts kBTU/hour Ton of AC	4,370 W 14.9 kBTU/hour 1.24 Tons of AC	5,132 W 17.5 kBTU/hour 1.46 Tons of AC	6,586 W 22.5 kBTU/hour 1.87 Tons of AC
Operating Assumption			
Cooking Mode Idle Mode Energy Save Mode Idle-Open Oven Cooking Shuttle Cooking Conv.	N/A N/A 34% of day 4.08 hrs/day 41% of day 4.92 hrs/day N/A 25% of day 3 hrs/day	N/A N/A 34% of day 4.08 hrs/day 41% of day 4.92 hrs/day N/A 25% of day 3 hrs/day	N/A N/A 34% of day 4.08 hrs/day 41% of day 4.92 hrs/day N/A 25% of day 3 hrs/day

* Different sized endstops available for Shuttles and Conveyors. Cook cavity dimensions are listed without endstops. Oventron is constantly improving and expanding our portfolio of cooking solutions. Visit oventionovens.com or more details.

This product is covered by patents in the US and other countries. UL® is a trademark of Underwriters Laboratories, Inc.

** Assuming \$0.11 energy cost and 12 hours of operation/day.

*** All specs subject to change based on final approvals. Additional and export plug configurations available upon request

SCAN HERE TO
VIEW SPEC SHEET



Heavy Duty Conveyor | 1600HD *COMING SOON

Simple, fortified version of our conveyor line for reliable operation.



STANDARD FEATURES

- Independently controlled top and bottom impingement air with 3 speed options (high, medium, low) recirculation
- Pending UL®-KNLZ certification for ventless operation
- New control panel: proven design, simple, intuitive functionality to draw cooler, cleaner air
- 3-speed blower design
- Additional internal airflow to keep oven cool
- Dishwasher safe jet plates
- Fortified construction for heavy use
- 1 year parts and labor warranty

OPERATION AND PERFORMANCE

- Intuitive front-facing color controls
- Recipe management and diagnostics via USB drive
- Grill, roast, bake, steam, broil, and air fry
- Use any oven-safe pans



Conveyor 1600HD

Heating Technology	Impingement
Capacity	
Maximum Pan Size Maximum Pie Size	Half Sheet Pan 16"
Exterior Dimensions*	
Height without Legs (legs approx. 4") Width Depth	16.66" (423 mm) 47.37" (1203 mm) 35.11" (892 mm)
Cook Cavity	
Height x Width x Depth Cook Surface/Belt Width x Depth Belt Options	3.3"x21.97"x16.92" (84x558x430mm) 38.78"x16.0" (985x406 mm) Single Belt
Features	
Stackable Recipe Stages USB Compatible UL® Ventless	Double/Triple Single Stage Recipe USB Compatible TBD
Power	
Plug	NEMA 6-50 NEMA 15-50
Energy Efficiency**	
Total Energy Cost/Day Total Energy Cost/Month Total Energy Cost/Year	TBD TBD TBD
Average Load***	
Watts	TBD
kBTU/hour	TBD
Ton of AC	TBD
Operating Assumption	
Cooking Mode	TBD
Idle Mode	TBD
Energy Save Mode	TBD
Idle-Open Oven	TBD
Cooking Shuttle	TBD
Cooking Conv.	TBD

* Different sized endstops available for Shuttles and Conveyors. Cook cavity dimensions are listed without endstops. Oventron is constantly improving and expanding our portfolio of cooking solutions. Visit oventronovens.com for more details.

This product is covered by patents in the US and other countries. UL® is a trademark of Underwriters Laboratories, Inc.

** Assuming \$0.11 energy cost and 12 hours of operation/day.

*** All specs subject to change based on final approvals. Additional and export plug configurations available upon request.



MiLO® | Single 14/Single 16/Double 16

MiLO utilizes a revolutionary infusion of linear impingement and infrared (IR) technologies. Independent top and bottom cavities, each with its own glass door, interior light and intuitive full-color touchscreen in a small footprint.



Choose from a variety of antimicrobial powder coat options!



STANDARD FEATURES

- Patented Linear Impingement heating technology uses hot air in cavity for an even, consistent cook with higher yield
- Independently controllable top and bottom IR elements provide caramelization without overdrying
- Full-color touchscreens for each cavity, allowing for each cavity to operate independently
- Glass door with illuminated interior
- Automatic Power Save mode when not cooking for maximum energy conservation
- Quiet; maximum decibel (dB) level of 68
- UL®-KNLZ certified for ventless operation
- Use MiLO-16 as a compact standalone unit or stack on a MiLO 2-16 for a ventless three-cavity configuration
- 1 year parts and labor warranty

OPERATION AND PERFORMANCE

- Store 1000+ multistage recipes
- Industry-leading online Menu Builder and recipe software allows for easy menu creation and management via USB
- Programmable cavity venting for humidity management
- Self-diagnostics for monitoring oven components and performance
- High visibility countdown timers
- Grill, roast, bake, steam, broil, and air fry
- Easy-to-clean design
- Use any oven-safe pans

	 MiLO® Single 14	 MiLO® Single 16/Double 16
Heating Technology	Linear Impingement and Infrared	Linear Impingement and Infrared
Capacity		
Maximum Pan Size Maximum Pie Size	Quarter Sheet Pan 14"	Half Sheet Pan 16"
Exterior Dimensions		
Height without Legs (legs approx. 4") Width Depth	21.74" (552mm) 23.41" (595mm) 32.58" (817mm)	16.5" (419mm) Single/30.90" (785mm) Double 28.99" (735mm) 33.00" (828mm)
Cook Cavity		
Height x Width x Depth Cook Surface/Belt Width x Depth Belt Options	4"x15.5"x16.1" (102x394x409mm) 15.5"x14.3" (394x363mm) N/A	4"x17.5"x18.48" (102x445x469mm) 16.75"x18.14" (425x461mm) N/A
Features		
Stackable Recipe Stages USB Compatible UL® Ventless	No Multi-stage Recipe USB Compatible Ventless	Double/Triple Multi-stage Recipe USB Compatible Ventless
Power		
Plug	NEMA 6-30 NEMA 15-50	NEMA 6-50 (MiLO 2-16 only) NEMA 6-30 (MiLO-16 only) NEMA 15-50
Energy Efficiency**		
Total Energy Cost/Day Total Energy Cost/Month Total Energy Cost/Year Average Load***	\$2.06 \$61.76 \$741.17	\$2.45 Sgle. / \$4.90 Dbl. \$ 73.59 Sgle. / \$146.89 Dbl. \$ 883.13 Sgle. / \$1,762.70 Dbl.
Watts kBTU/hour Ton of AC	1,586 W 5.4 kBTU/hour 0.45 Tons of AC	1,868 W Sgle. / 3,709 W Dbl. 6.35 kBTU/hr Sgle. / 12.67 kBTU/hr Dbl. 0.53 Tons of AC Sgle. / 1.06 Tons of AC Dbl.
Operating Assumption		
Cooking Mode Idle Mode Energy Save Mode Idle-Open Oven Cooking Shuttle Cooking Conv.	25% of day 3 hrs/day 75% of day 9 hrs/day N/A N/A N/A N/A	25% of day 3 hrs/day 75% of day 9 hrs/day N/A N/A N/A N/A

This product is covered by patents in the US and other countries. UL® is a trademark of Underwriters Laboratories, Inc.

** Assuming \$0.11 energy cost and 12 hours of operation/day.

*** Measurements shown with 1phase options. 3phase numbers available upon request. All specs subject to change based on final approvals. Additional and export plug configurations available upon request.



SCAN HERE TO VIEW SPEC SHEET



Finishing Oven | F1400

Finish your plates with ease and precision with this robust IR finishing oven. Melt, sear, toast and finish to perfection with this operator-friendly, quiet conveyor.



STANDARD FEATURES

- Quick-heating infrared elements and microprocessor to control temperature and cook time
- Full-color touchscreen display with security passcode and color controls
- Independently control belt speed, belt direction, and heat on top and bottom from 0-100%
- Patented Hatco® ColorGuard sensing system monitors and adjusts conveyor speed and temperature during high usage periods to ensure product color uniformity
- Built-in Power Save mode
- Ultra quiet operation with a maximum decibel (dB) of 54
- Maximum internal temp of 825° F
- UL®-KNLZ listed ventless operation for re-thermalization of pre-cooked product
- 1 year parts and labor warranty

OPERATION AND PERFORMANCE

- Holds 4 recipe settings
- Melts cheese in as little as 20 seconds
- Fits up to 14" pizza, half-size sheet pan
- Perfect for melting toppings, finishing foods like potato skins, soup, nachos, as well as toasting buns and bread
- Great for re-thermalizing frozen or fresh foods like appetizers, french fries, and pizza
- Use any oven-safe pans



Finishing Oven F1400

Heating Technology	Infrared Finishing
Capacity	
Maximum Pan Size Maximum Pie Size	Half Sheet Pan 14"
Exterior Dimensions*	
Height without Legs (legs approx. 4") Width Depth	14.5" (368 mm) 38.57" (980 mm) 23.94" (608 mm)
Cook Cavity	
Height x Width x Depth Cook Surface/Belt Width x Depth Belt Options	4.0"x18.47"x14.59" (102x469x371mm) 38.5"x14" (978x356mm) Single Belt
Features	
Stackable Recipe Stages USB Compatible UL® Ventless	Double/Triple Single Stage Recipe USB Compatible Ventless
Power	
Plug	NEMA 6-50 NEMA 6-30
Energy Efficiency**	
Total Energy Cost/Day Total Energy Cost/Month Total Energy Cost/Year	\$7.62 \$229.00 2,748.00
Average Load***	
Watts kBTU/hour Ton of AC	5,871 W 20.1 kBTU/hour 1.67 Tons of AC
Operating Assumption	
Cooking Mode Idle Mode Energy Save Mode Idle-Open Oven Cooking Shuttle Cooking Conv.	N/A N/A 34% of day 4.08 hrs/day 41% of day 4.92 hrs/day N/A 25% of day 3 hrs/day

* Different sized endstops available for Shuttles and Conveyors. Cook cavity dimensions are listed without endstops. Ovention is constantly improving and expanding our portfolio of cooking solutions. Visit oventionovens.com for more details.

This product is covered by patents in the US and other countries. UL® is a trademark of Underwriters Laboratories, Inc.

** Assuming \$0.11 energy cost and 12 hours of operation/day.

*** All specs subject to change based on final approvals.



SCAN HERE TO VIEW SPEC SHEET



MISA® | Sizes a12/a16*

MISA stands for **Microwave Speed Assist**. Cook up to 10x faster than conventional ovens without sacrificing quality. Our patent-pending cook plate technology gives you superior browning in less time. Higher quality, higher speed, smaller footprint.



STANDARD FEATURES

- Highest convection heat, largest cavity volume, and quietest work environment in its size category (64 dB)
- Easy-to-clean non-stick (PTFE) liner on most interior surfaces
- Patent-pending artisanal cook plate for superior browning
- High visibility countdown timer
- Top launched microwave system with dual magnetrons and stirrers to ensure even distribution
- Certified UL®-KNLZ ventless individually and with two units on stacking cart
- 1 year parts and labor warranty

OPERATION AND PERFORMANCE

- Simple, intuitive touchscreen can store 1000+ recipes with dozens of standard icons and full color product images
- Cooks up to 10 times faster than conventional ovens
- Use any oven-safe pans
- Fits a 12" pizza, quarter-size sheet pan (custom 12.65 x 13.35 pans available)
- Perfect for certain food products like breakfast sandwiches, taquitos, corn dogs, egg rolls and more
- Industry-leading online Menu Builder and recipe software allows for easy menu creation and management via USB
- Self-diagnostics for monitoring oven components and performance
- Grill, roast, bake, steam, broil, and air fry
- Easy-to-clean design

*MISA-a16 Coming Soon

	 MISA®-a12
Heating Technology	Microwave Speed Assist
Capacity	
Maximum Pan Size Maximum Pie Size	Quarter Sheet Pan 12"
Exterior Dimensions	
Height without Legs (legs approx. 4") Width Depth	22.26" (566mm) 16" (407mm) 32.78" (833mm)
Cook Cavity	
Height x Width x Depth Cook Surface/Belt Width x Depth	6.4"x12.9"x13.56" (163x328x345mm) 12.25"x12.00"(311x304mm)
Features	
Stackable Recipe Stages USB Compatible UL® Ventless	Double via Stacking Cart Multi-stage Recipe USB Compatible Ventless
Power	
Plug	NEMA 6-30
Energy Efficiency**	
Total Energy Cost/Day Total Energy Cost/Month Total Energy Cost/Year	\$2.45 \$73.49 \$881.83
Average Load*** Watts kBTU/hour Ton of AC	1,856 W 6.3 kBTU/hour 0.53 Tons of AC
Operating Assumption Cooking Mode Idle Mode Energy Save Mode Idle-Open Oven Cooking Shuttle Cooking Conv.	25% of day 3 hrs/day 75% of day 9 hrs/day N/A N/A N/A N/A

This product is covered by patents in the US and other countries. UL® is a trademark of Underwriters Laboratories, Inc.

** Assuming \$0.11 energy cost and 12 hours of operation/day.

*** All specs subject to change based on final approvals.



SCAN HERE TO
VIEW SPEC SHEET



Ovention®
offers a wide
range of
accessories...

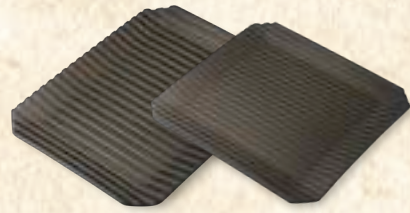

Grill Plates

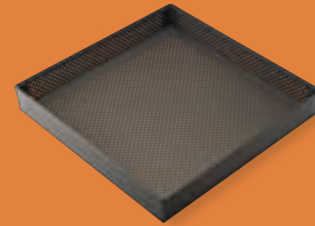

Fry Basket



Pizza Rocker



Warming Tray



Pizza Peel



Crisping Tray



Cleaner and Polish



Egg Pans



Oven Stands



Mesh Non-Stick
Hot Dog Tray



Paddle



Cleaning Brushes



Premium Care Packages

Specialty pans and accessories are available through
your local dealer or at oventionovens.com

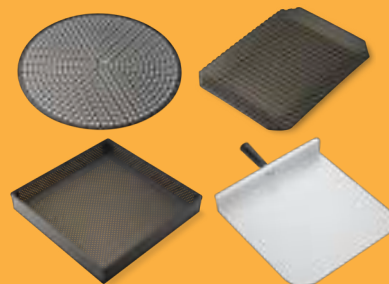

Premium Accessories
Packages

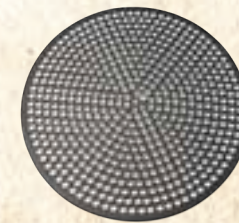

Heavy Duty
Pizza Screens

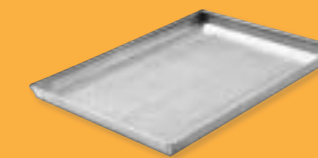

Perforated Pan

...to cook,
finish, and
serve your
product the
way YOU
want!

Antimicrobial powder coat

All powder coat options now come standard with an antimicrobial additive.

Antimicrobial coatings use naturally-occurring, environmentally sustainable silver ions to help inhibit the growth of microbes on the powder coated surfaces of the oven.

How do the coatings work? When moisture is present, the antimicrobial coatings release silver ions, which attach to a microbe's cellular structure to inhibit its growth. The coatings also retain their antimicrobial protection over time.

The silver ions offer protection against microbes that cause odor, mildew and spoilage without high toxicity to humans and animals.



Choose from a variety of antimicrobial powder coat options!



CANDY APPLE



BURNT ORANGE



SWEET POTATO



MAC & CHEESE



LEMON



LIME



BLUE CURAÇAO



BLUEBERRY



SEAWEED



GRAPHITE



BLACK

What can I cook?

At Ovention®, we think ovens should be smart enough to cook your entire menu perfectly, every time.



GRILL

Paninis | Precooked Bratwurst
Shrimp | Pineapple
Vegetables



BROIL

Lobster Tails | Zucchini
Shrimp | Fish
Stuffed Mushrooms



AIR FRY

Precooked Chicken Wings
Onion Rings | Tater Tots
French Fries | Mozzarella Sticks

BAKE

Cookies | Pizza | Biscuits
Spinach & Artichoke Dips
Soufflé

STEAM

Vegetables | Rice
Pasta | Fish
Mussels

RAPID COOK

Taquitos | Corn Dogs
Precooked Meatballs
Breakfast Burritos | Egg Rolls



Cooking times

See how fast you can cook with an Ovention oven.



MATCHBOX®

Jumbo Pretzel (Frozen) | 1:45
Glazed Donut (Retherm) | 0:45
Potato Wedges | 3:30



SHUTTLE®

Quesadilla | 2:00
Flatbread | 1:45
Waffle Fries | 3:00



MISA®

Ham & Cheese Sandwich | 0:30
Egg Rolls (Frozen) | 2:30
Precooked Wings (Frozen) | 3:30



CONVEYOR

Par Baked Pizza | 2:30
Toasted Sub | 0:50
Asparagus | 2:00



MILO®

Cheesy Bread | 1:15
Bell Peppers | 2:15
Fresh Dough Pizza | 3:30



FINISHING OVEN

Nachos | 0:30
Baked Pasta | 2:00
Burrito | 0:30

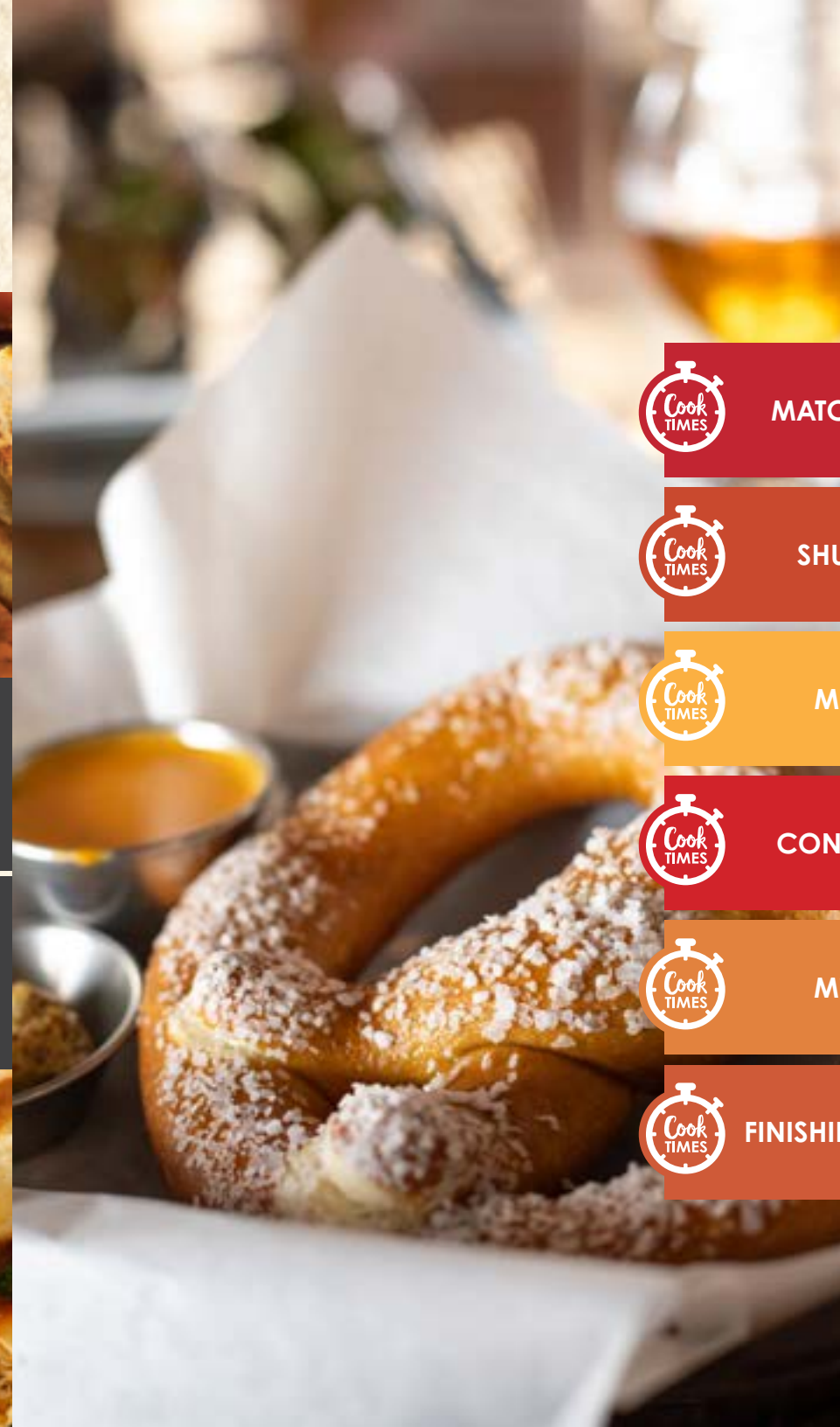

Ovention® has given us universal utility. It is the **heart** of our kitchen.

– S2000 customer

If I want to customize, I can do that with the speed, time or heat...

It's a really, really good tool to have.

– MiLO® 14 customer

I love its consistency.

It does its job.

– Conveyor customer

This oven is very user friendly. There's no guesswork....

It's been worth its weight in gold.

– M1718 customer

OVENTION
A HATCO CORPORATION COMPANY